

# INSTALLATION MANUAL

---

# WHITE SHANTY



WS-1

R2

Illustrations are general and may not match your specific door design.

## CALIFORNIA PROPOSITION 65 RAW WOOD PRODUCT EXPOSURE



WARNING: Drilling, sawing, sanding or machining wood products can expose you to wood dust, a substance known to the State of California to cause cancer. Avoid inhaling wood dust or use a dust mask or other safeguards for personal protection. For more information go to [www.P65Warnings.ca.gov/wood](http://www.P65Warnings.ca.gov/wood)

## CALIFORNIA PROPOSITION 65



WARNING: This product can expose you to chemicals including formaldehyde, ethylbenzene, titanium dioxide, cumene, carbon black, silica and wood dust, which are known to the State of California to cause cancer, and toluene, which is known to the State of California to cause birth defects or other reproductive harm. For more information go to [www.P65Warnings.ca.gov](http://www.P65Warnings.ca.gov)

## IMPORTANT MESSAGE

On behalf of everyone at White Shanty, we would like to thank you for your purchase of one of our products. This product is designed and manufactured in the USA. This door comes with an Installation Manual. It is important that you read and fully understand this manual prior to installation. Following the steps exactly as specified in the manual will ease installation and reduce the amount of time necessary to complete the process. Keep this manual even after the installation process has been completed. Understand how to use tools that may be required during the installation process. Observe all safety warnings called out in this manual. Make sure those who may install this product for you understand this manual as well as you do.

White Shanty  
106 GP Clement Drive  
Collegeville, PA 19426

### Table of Contents

Preparing for Installation .....	3	Roller and Door Installation .....	7
Parts & Hardware .....	4	Guide and Anti Jump Lock Installation .....	8
Top Mount Roller Installation .....	5	Exploded View .....	9
Face Mount Roller Installation .....	6	Warranty .....	10

### NOTICE !!!

Unauthorized modifications may present extreme safety hazards and could also result in injury or product damage. White Shanty strongly warns against, rejects and disclaims any modifications, add-on accessories or product alterations that are not designed, developed, tested and approved by White Shanty's Engineering Department. Any White Shanty product that is altered, modified or changed in any manner not specifically authorized after original manufacture – including the addition of “aftermarket” accessories or component parts not specifically approved by White Shanty – will result in the White Shanty warranty being voided. Any and all liability for personal injury and/or property damage caused by any unauthorized modifications, add-on accessories or products not approved by White Shanty Stairs will be considered the responsibility of the individual(s) or company designing and/or making such changes. White Shanty will vigorously pursue full indemnification and costs from any party responsible for such unauthorized post-manufacture modifications and/or accessories should personal injury and/or property damage result.

 <p style="margin: 0;">This symbol means: <b>ATTENTION! BECOME ALERT!</b></p> <p style="margin: 0;">Your safety and the safety of others is involved. <b>Signal word definitions:</b> The signal words below are used to identify levels of hazard seriousness. For your safety and the safety of others, read and follow the information given with these signal words and/or the symbol shown above.</p>	<div style="border: 1px solid black; padding: 2px; margin-bottom: 5px; background-color: #ffcc00; text-align: center;"><b>⚠ WARNING</b></div> <p style="margin: 0;"><b>WARNING</b> indicates a potentially hazardous situation which, if not avoided, <b>COULD</b> result in death or serious injury.</p> <hr/> <div style="border: 1px solid black; padding: 2px; margin-bottom: 5px; background-color: #ffff00; text-align: center;"><b>⚠ CAUTION</b></div> <p style="margin: 0;"><b>CAUTION</b> indicates a potentially hazardous situation which, if not avoided, <b>MAY</b> result in minor or moderate injury. It may also be used to alert against unsafe practices or property damage.</p> <hr/> <div style="border: 1px solid black; padding: 2px; margin-bottom: 5px; background-color: #ffff00; text-align: center;"><b>CAUTION</b></div> <p style="margin: 0;"><b>CAUTION</b> used without the safety alert symbol indicates a potentially hazardous situation which, if not avoided, <b>MAY</b> result in property damage</p>
<div style="border: 1px solid black; padding: 2px; margin-bottom: 5px; background-color: #ff0000; color: white; text-align: center;"><b>⚠ DANGER</b></div> <p style="margin: 0;"><b>DANGER</b> indicates an imminently hazardous situation which, if not avoided, <b>WILL</b> result in death or serious injury.</p>	



## Preparing For Installation

---

### Read the Installation Manual

- If anyone involved in the installation process cannot read English, it is the owner's responsibility to explain the contents of this manual to them.
- If any portion of this manual is unclear, contact the White Shanty Customer Service Department for clarification.
- It is the owner's responsibility to be familiar with the use of any tools that may be necessary to complete the installation of this product. Read the manual for these specific tools.
- Do not install or allow anyone to install this product if there are any questions about the installation process.
- Never attempt to install this product if any of the components are damaged or have any unauthorized modifications.
- All persons should be trained. The owner is responsible for training the users.
- Wear the appropriate personal protective equipment during installation.
- Wear hearing protection.
- Wear safety glasses.
- Wear a dust mask to avoid breathing dust.
- Never allow children, unskilled or improperly trained people to participate in the installation process.
- Keep the Installation Manual legible and intact.
- Do not attempt to install this product while under the influence of drugs or alcohol.
- The owner/user can prevent and is responsible for accidents or injuries occurring to themselves, other people or property.

### Site Preparation

- Check the area where the product is to be installed.
- Be sure the area is clear of pets and people, especially young children. Stop the installation process if any enter the area.
- Installation should be done in daylight or in good artificial light.
- Only use components approved by the manufacturer.

### Installation Preparation









- Do not tamper with any component.
- Use extra care when unloading or moving any component. Some components may be heavy and require multiple people to move them safely.
- Keep all fasteners such as nuts and bolts well secured.
- Verify that all components are in good condition and are not damaged in any way.
- Do not start the assembly process until you read the Installation Manual.
- Do not use the door(s) until the assembly process is complete.

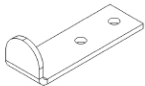
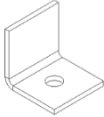



### Suspending the Installation Procession

- If it is necessary to suspend the installation process, it is the owner's responsibility to mark off the area to limit access until the installation is complete.
- Do not allow anyone to use the door(s) until the assembly process is complete.

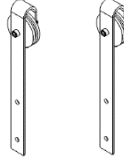
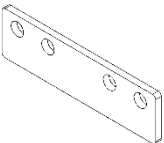
# Parts & Hardware



				
① Anti Jump Lock	② Door Stop	③ 2" Spacer	④ 1" Spacer (optional)	⑤ Spacer Wall Plate (optional)
				
⑥ U-Style Floor Guide	⑦ L-Style Floor Guide (optional)	⑧ Door	⑨ Track	⑩ Roller Assembly
				
⑪ Track Coupler (optional)				

Item	Description	Item	Description
Ⓐ 	3/8" X 5" Lag Screw	Ⓔ 	1" Wood Screw
Ⓑ 	3/8" -16 x 1" Hex Bolt	Ⓕ 	3/8-16 Hex Bolt (length based on door thickness)
Ⓒ 	3/8" Flat Washer	Ⓖ 	1/4" x 2-1/2" Lag Screw
Ⓓ 	3/8" -16 Hex Nut		

## Top Mount Roller Installation

1. Determine the location of the top mount roller strap assemblies (10) on the top of the door (8) and mark the hole locations on the door. The roller should be centered on the door and 2-1/2" from each end of the door.
2. Drill holes into the top edge of the door with a 3/16" drill bit at the locations marked in step 1. The depth of the hole shall be 2-1/2".
3. Attach the roller straps to the door using the lag screws (G)

### Hardware

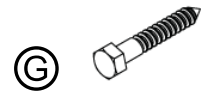

### Parts



### Tools

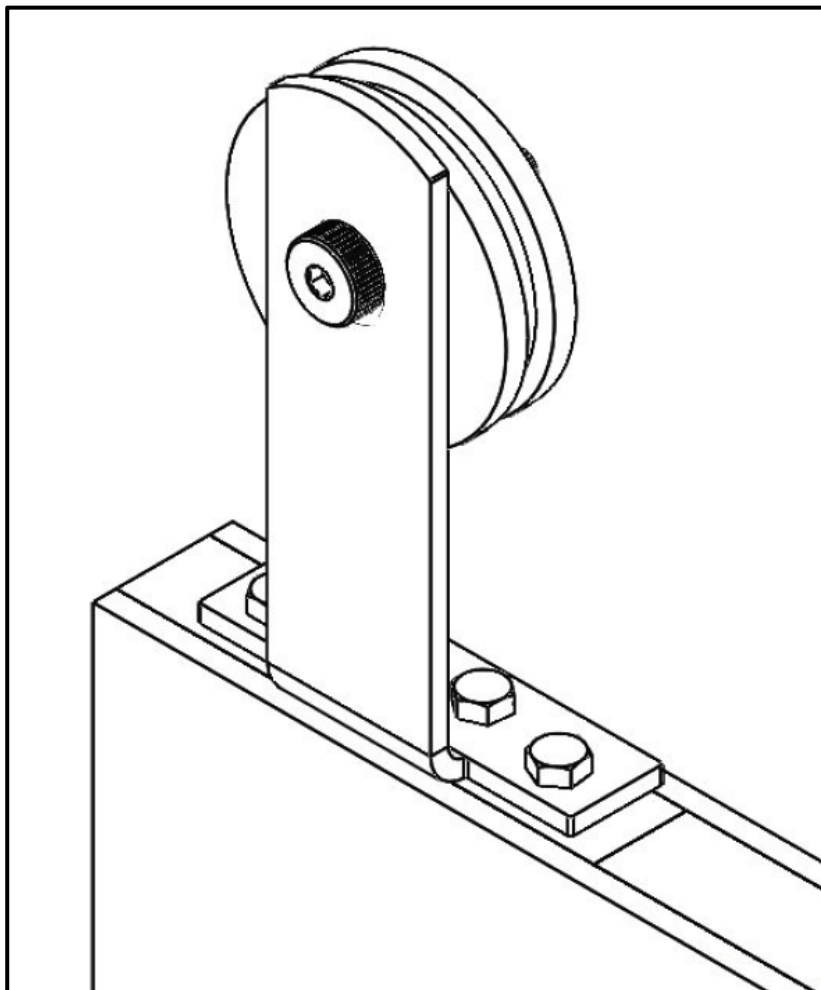

## Face Mount Roller Installation

1. Determine the location of the roller strap assemblies (10) on the door (8) and mark the hole locations on the door. The center of the roller should be 2-1/2" from the edge of the door. The bottom of the roller should be located 2-1/2" from the top of the door.
2. Drill holes through the door with a 3/8" drill bit at the locations marked in step 1.
3. Attach the roller straps to the door using the hex bolts (F), washers (C) and nuts (D) s shown in the assembly diagram.

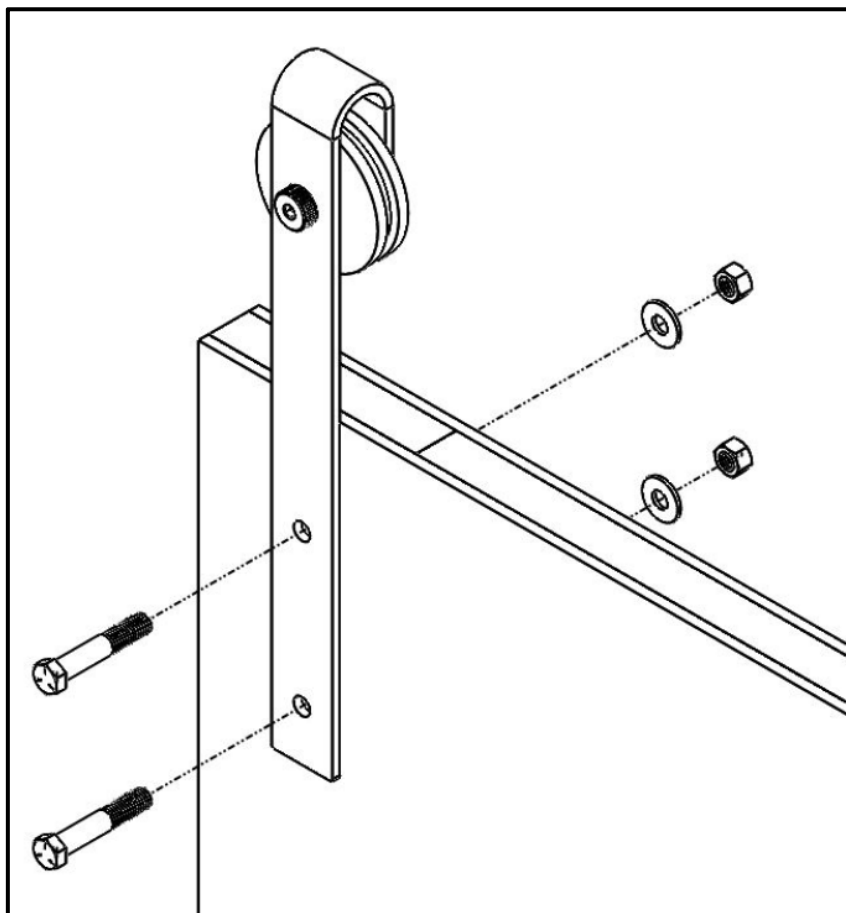

### Hardware

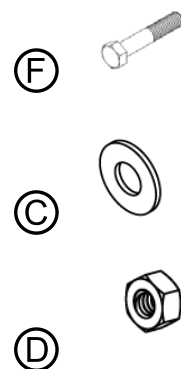

### Parts



### Tools

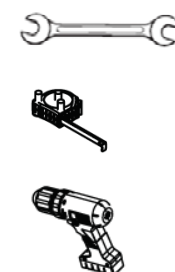

## Track and Door Installation

- Determine the location of the wall mounting lag screws (A) and mark the position on the track (9). The mark should be centered on the track.

<b>⚠ WARNING</b>	The wall mounting lag screws must be installed into wall studs. Failure to install the lag screws into the studs could make the door unstable and could result in serious injury.
------------------	---

- Drill holes through the track with a 3/8" drill bit at the locations marked in step 1.
- Mark the position of the door stops on the track. Center the mark on the track. In most cases the hole should be located 2" from each end of the track.
- Drill holes for the door stops through the track with a 3/8" drill bit.
- Mount the door stops onto the track using cap screws (B), flat washers (C) and nuts (D).

<b>⚠ WARNING</b>	The door stops must be installed prior to operating the door. Failure to install the door stops can result in serious injury or death if the door falls off the end of the track.
------------------	---

- Attach the track to the wall using mounting lag screws (A). Be sure to place the spacer (3) between the track and the wall. The exact location of the track will need to be determined in the field. In order to have approximately 1/2" clearance at the bottom of the door, the track should be installed so that the center of the track is located on a level line that is equal to the height of the door + 2 1/2". This dimension should be adjusted based on your specific application.

<b>⚠ WARNING</b>	The door track must be mounted so that it is level. Failure to mount the track level may result in the door moving unexpectedly and may result in serious injury.
------------------	---

- With the help of another person, carefully put the door in place by lifting and gently placing the rollers on the track.
- Depending on the overall length of the track, it may have been shipped in two sections. Use the track coupler (11) and cap screws (B) and nuts (D) to secure the two sections of track together. Drill holes for the track coupler through the track with a 3/8" drill bit. Be sure to place the larger section of the coupler towards the bottom of the track to avoid interference with the roller.

<b>⚠ WARNING</b>	Doors are heavy and require two people to lift into position. Do not attempt to lift the door into position without assistance.
------------------	---

### Hardware

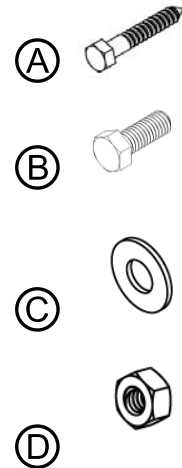

### Parts



### Tools

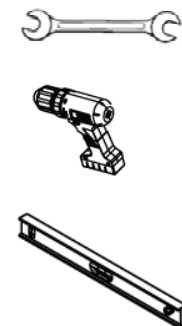



## Guide and Anti Jump Lock Installation

1. Locate the mounting position of the U-Style door guides (6) just beside the opening on the side of the door slide direction.
2. If you upgraded to the L-Style door guide, your door will have a slot cut in the bottom of the door to accept the L-Style guide. Locate the mounting position of the L-Style door guide (7) just beside the opening on the side of the door slide direction.
3. Choose the appropriate 1/4" fasteners for your floor type and attach the door guide(s) to the floor. These fasteners are not included.

### Hardware



### Parts



### Tools

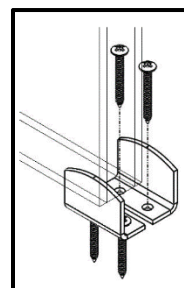
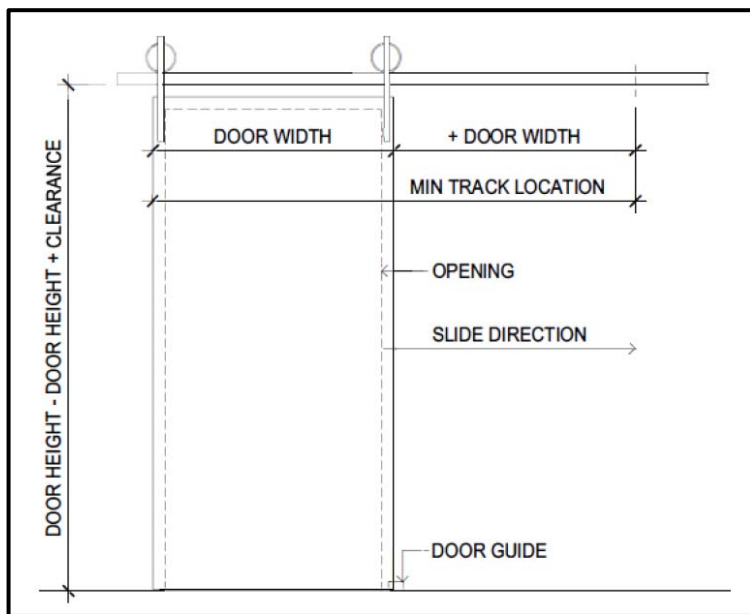

4. Install the anti jump locks (1) onto each end of the door 1/8" below the bottom of the track.
5. Attach the anti jump locks to the door using the wood screws (E).

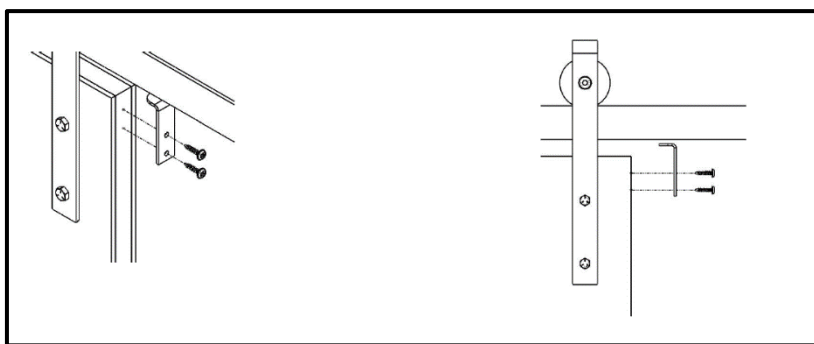

**WARNING**

The anti jump locks must be installed prior to operating the door. Failure to install the anti jump locks can result in serious injury or death if the door jumps off the track.

# Assembly View

